

TERA® 1-pair shielded plug cable preparation and termination instructions

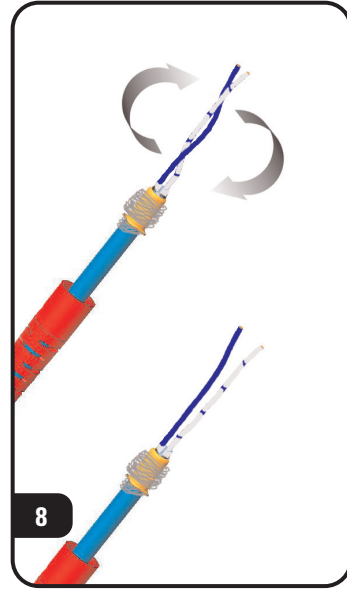

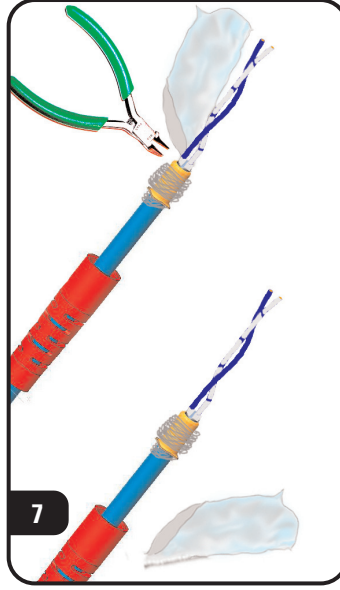
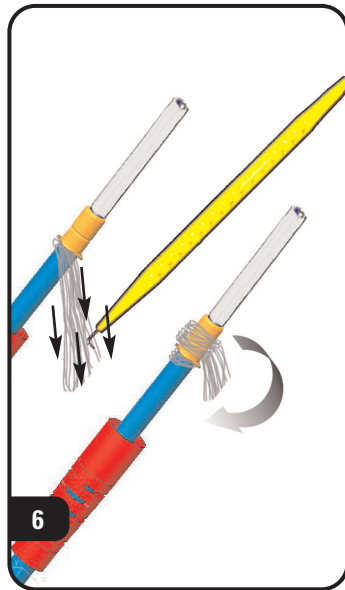
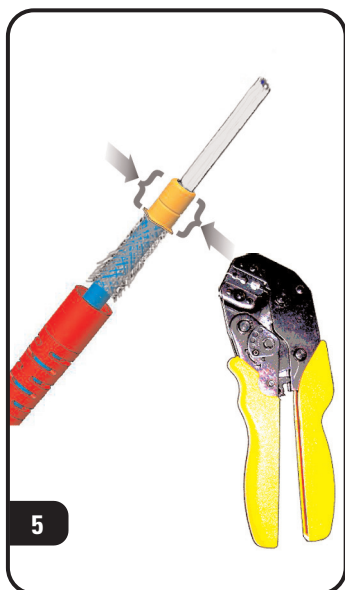
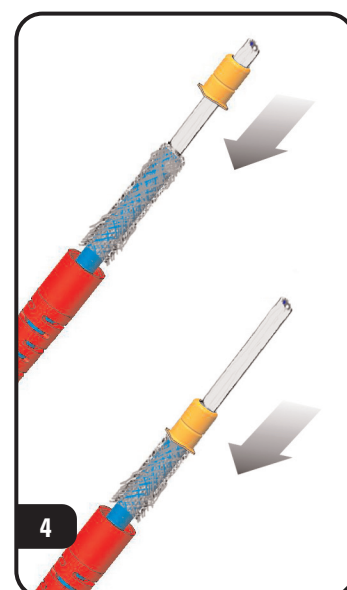
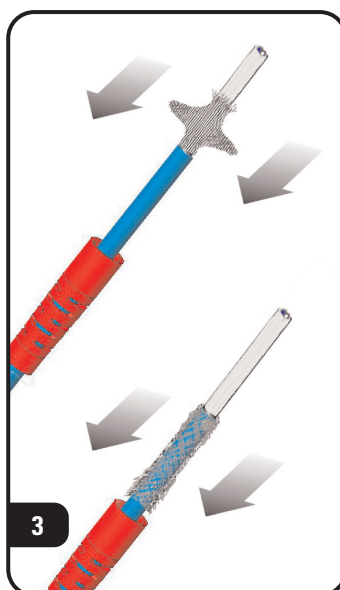
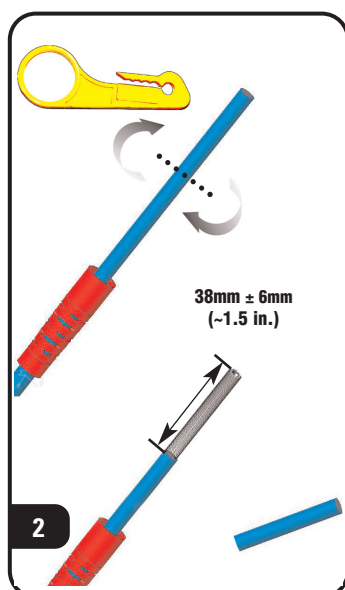
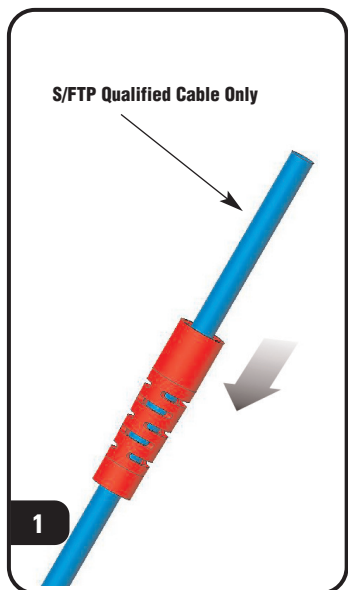
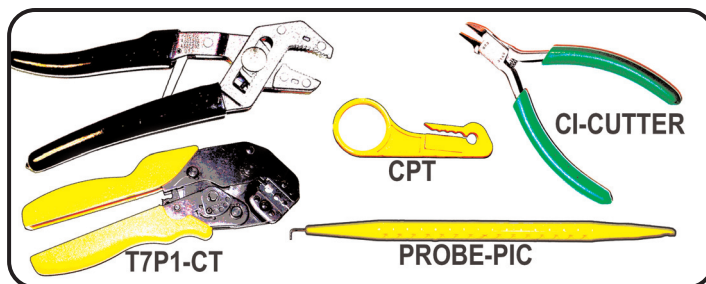
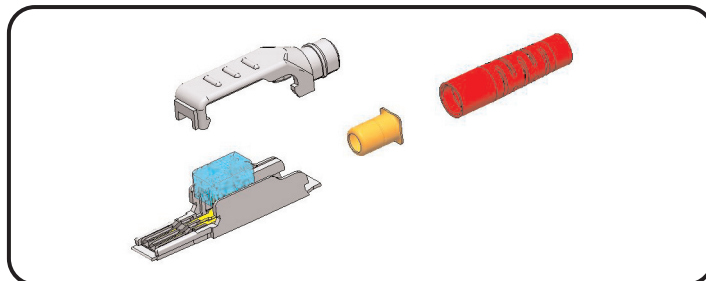
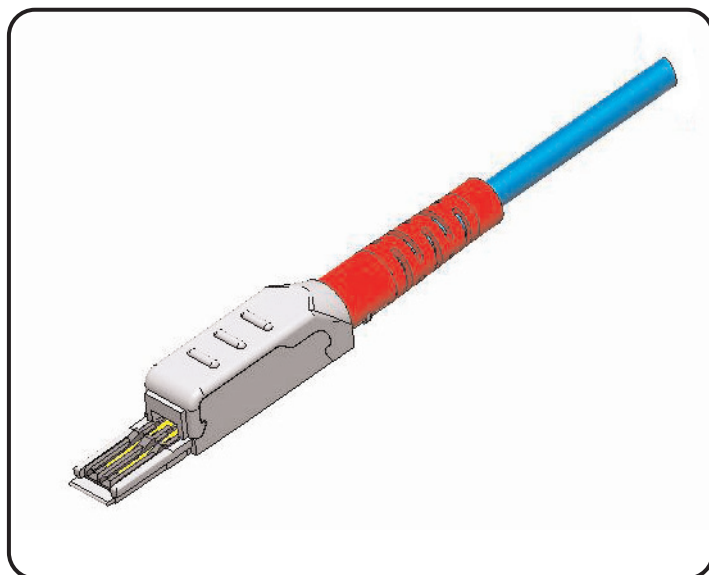
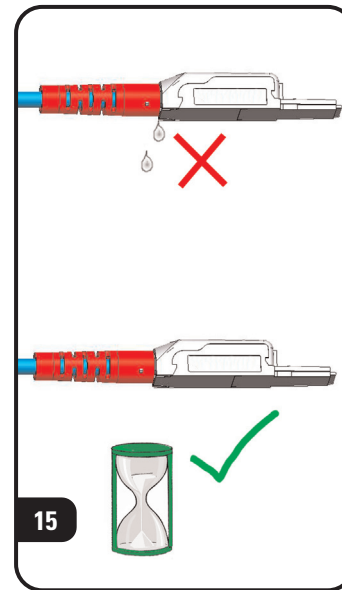
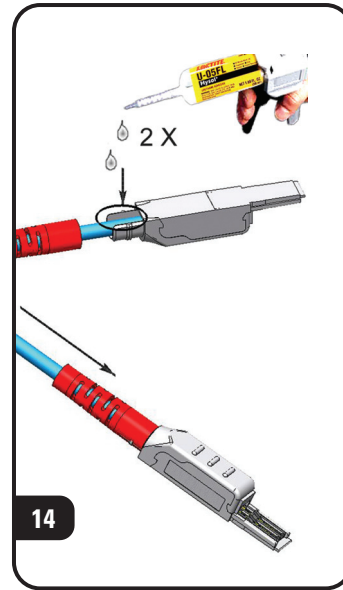
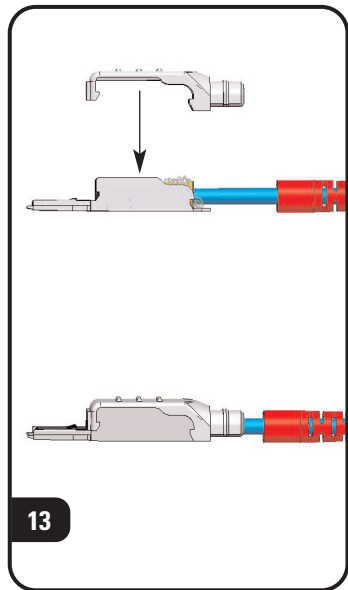
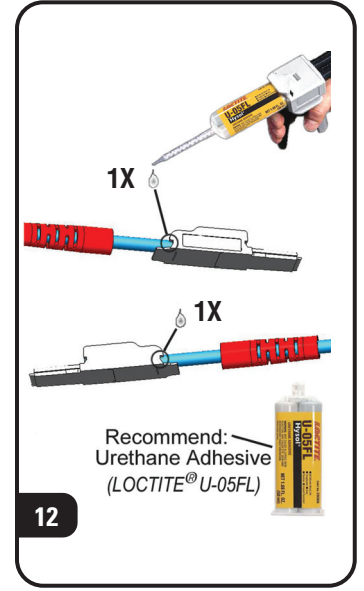
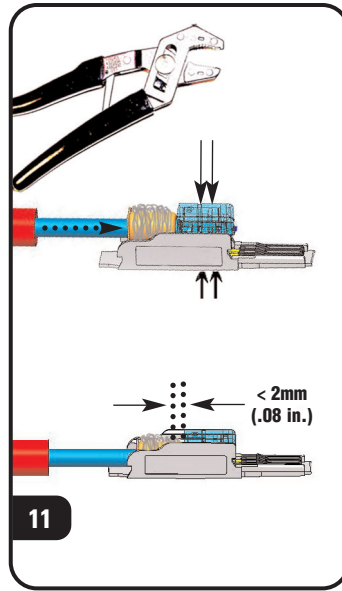
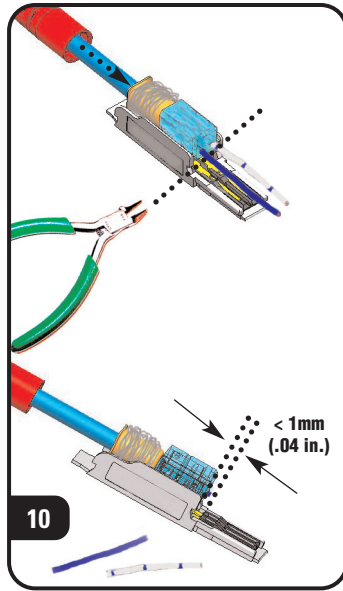
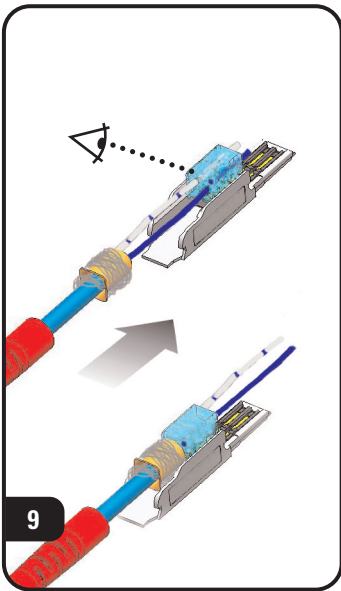

To assist safe installations, comply with the following:

- A. Use caution when installing or modifying telecommunications circuits.
- B. Never touch uninsulated wire terminals unless the circuit has been disconnected.
- C. Never install this device in a wet location.
- D. Never install wiring during a lightning storm.



Siemon — Australia
Sydney, Australia
Tel: (61) 2 8977 7500

Siemon — China
Beijing, P.R. China
Tel: (86) 10 6559 8860

Siemon — Germany
Frankfurt, Germany
Tel: (49) (0) 69 97168 184

Siemon — Latin America
Coral Gables, Florida USA
Tel: (1) 305 446 9150

Siemon — UK
Chertsey, Surrey
Tel: (44) (0) 1932 571771

Siemon — Canada
Whitby, Ontario
Tel: (1) 888 425 6165

Siemon — France
Paris, France
Tel: (33) 1 46 46 11 85

Siemon — Italy
Milano, Italy
Tel: (39) 02 64 672 209

Siemon — Southeast Asia
Singapore
Tel: (65) 345 9119

Siemon — USA
Watertown, Connecticut
Tel: (1) 866-548-5814



www.siemon.com