

# V600 Cabinet Assembly - Frame Kit Assembly

**Required Tools**

13mm Wrench  
 24mm Wrench  
 T30 Torx Driver



**1-1** Gather frame kit and ensure following components are present: **four** universal vertical frame posts [1], **one** cabinet hardware kit [2], and **two** top/base frames [3].

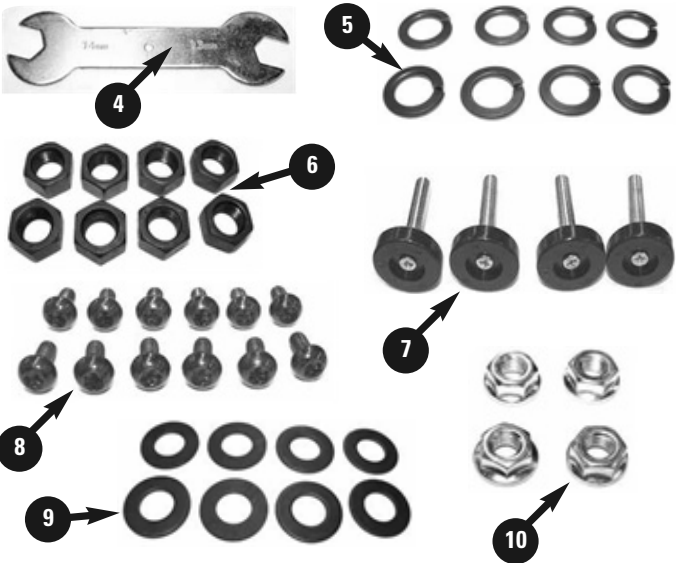

**1-2** Open hardware kit and verify all components are present. Kit will include **one** wrench [4], **eight** M16 spring washers [5], **eight** M16 hex nuts [6], **four** leveling feet [7], **twelve** M6-12 torx head screws [8], **eight** M16 flat washers [9], and **four** M6 flange nuts [10]

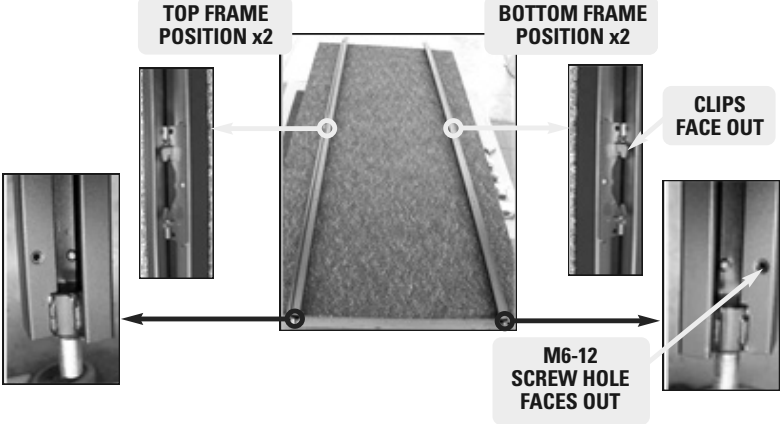

**1-3** Position vertical frames as shown. Ensure **two** of the vertical frames are positioned with clips and M6-12 screw holes on the right side and the other **two** vertical frames are positioned with clips and M6-12 screw holes on the left.

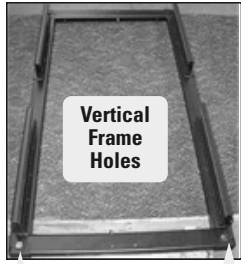

Vertical Frame Holes



Side Panel Slots Face Inward

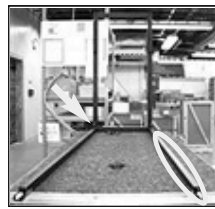

Clips Face Out



M6-12 Screw Holes Align

Edges are Flush

**1-4** Position **one** base/top frame on one end as shown ensuring side panel slots on frame face in as shown. Slide threaded end of vertical frames through designated holes on base/top frame as shown ensuring clips face out, M6-12 screw hole on vertical frame aligns with designated screw hole on Base/Top, and edge of vertical frame is flush against edge of Base/Top frame.

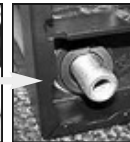
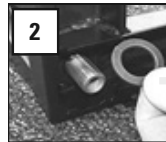
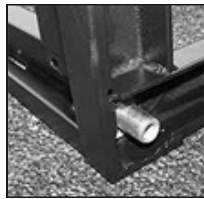

Nut must remain loose on vertical frame

**1-5** Ensure threaded end of vertical frames are through designated holes on base/top frame. Slide **one** washer over threaded end as shown. Place **one** spring washer on threaded end and secure with **one** M16 hex nut.

**NOTE: Tighten nuts loosely by hand.**

**1-6** Using T30 Torx screwdriver, install **one** M6-12 screw into each designated hole on frame as indicated ensuring screw is secure and edges of frame are flush.

**NOTE: Torque screws to 77-83 in-lbs of torque.**

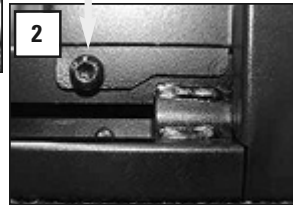
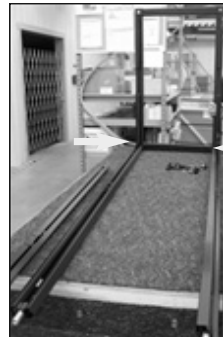

**1-7** Align second Base/Top frame with remaining end of vertical frame and repeat steps 1-4 to 1-6.



Ensure Clips on Vertical Frames Face Out

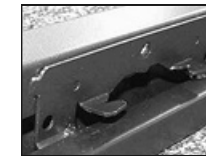

**1-8** Align remaining vertical frames with designated holes on Base/Top frame as shown ensuring clips on vertical frames point out. Repeat steps 1-5 to 1-6 ensuring frames are secure.



**1-9** Using a ratchet, tighten each M16 hexagonal nut on frame as indicated ensuring nuts are secure and vertical frames remain perpendicular with base/top frames.

**NOTE: Torque screws between 65-70 in-lbs [7.34 - 7.91 N-m].**



TOP

BOTTOM

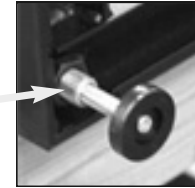
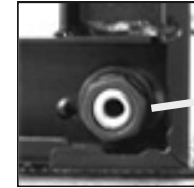

**1-10** Install **four** leveling feet into threaded ends of vertical frame on bottom of base.

**If installing castors, please follow steps 1-11 and 1-12. If not, please proceed to step 1-13**

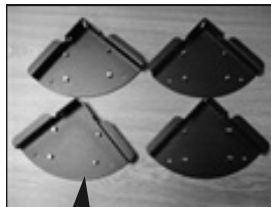

11



12



13

**1-11** Gather Castor kit and ensure following components are present: **four** universal mounting plates [11], **one** hardware kit [12], and **four** castor assemblies [13].

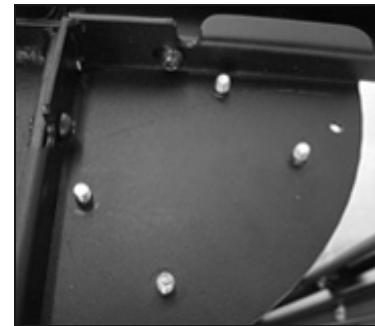

**1-12** Install **four** universal mounting plates using 8 M6 Torx head screws. Attach Castors to the four pems using **four** M6 Flange Nuts for each castor.

**NOTE: Torque screws to 77-83 in-lbs of torque.**

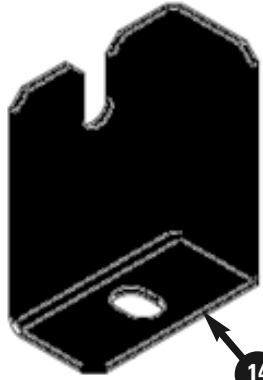

**1-13** Gather **four** top panel mounting brackets [14].

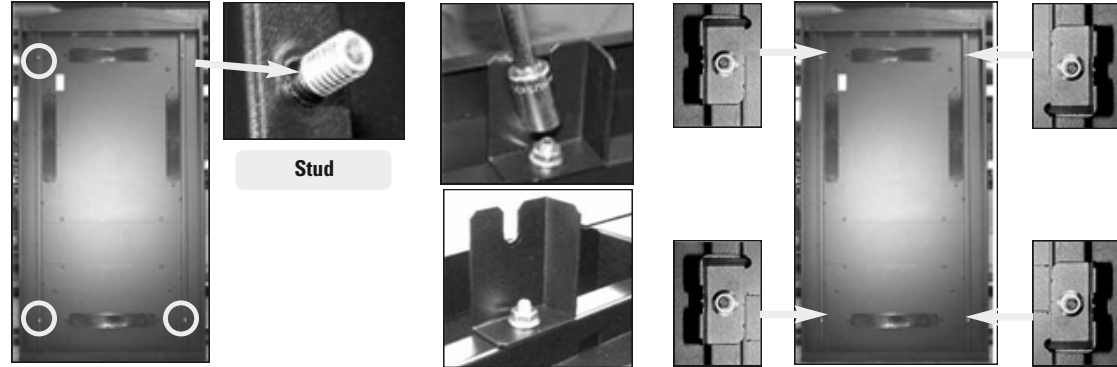

**1-14** Align hole on bracket with stud on top pane ensuring bracket is oriented accordingly. Using a socket wrench, install **one** flange nut to secure bracket as shown.

**NOTE: Tighten nuts loose.**

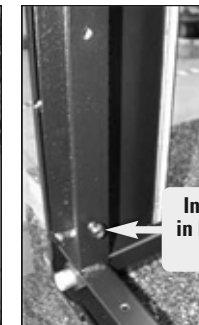
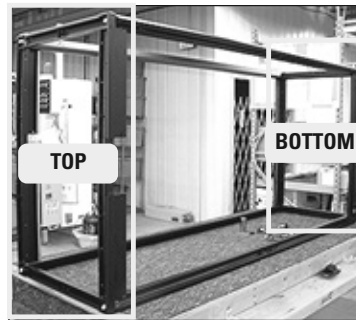

**1-15** Using T30 Torx screwdriver, install **four** M6-12 screws approximately halfway into designated holes on top end of frame as shown. Install into hole on Top frame closest to corner.

1

Notch

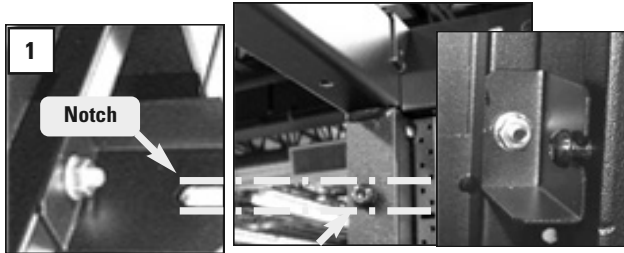

1-16 Align cover/brackets subassembly to frame by aligning notch on each bracket to designated screw on frame as shown. Tighten screw and flange nut.

**NOTE:**  
Torque screws and flange nuts to 35-40 in-lbs of torque.

2

Notch and Screw are Aligned



3

Tighten Screw and Flange Nut



1-17 Carefully raise cabinet to standing position.

**NOTE: TWO operators are required to lift and move the frame. Do not attempt to move frame alone.**

**NOTE: There are TWO mounting rails in each package. Left mounting rail will have a blue stripe on package label and right mounting rails will have a red stripe on package label.**



Left Rail



Blue Stripe

15



Right Rail

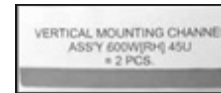

Red Stripe

16

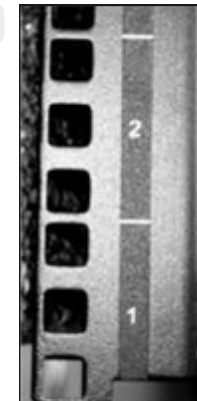

1-18 Note difference between left and right vertical mounting rails. Gather left [15] mounting rail kit and right mounting rail kit [16].

**1-19** Slide mounting rails onto frame accordingly ensuring bracket on top and bottom of rail slides into guides on top/base frames as shown. Push each rail to edge of frame ensuring face of rail is flush against side of frame as shown.

**Left Rail** **Right Rail**

**1** **2** **Bracket** **Guide**

**Slide Bracket on Rail 2 Through designated Guide on Base/Top Frames**

**Edge of Rail and Frame are Flush**

**Right Rail** **Left Rail**

**1-20** Push torx screws up on top and bottom of each rail to lock rail in place.

**NOTE: Torque each screw to to 35-40 in-lbs of torque.**

**Push Screw Up and Torque**

**2** **3**

**Screw Down, Rail Loose**

**Rail Locked to Frame**

**17** **Center Clips**

**1-21** Gather **one** designated center bracket [17]. Locate center clips on mounting rails of cabinet frame.

**1** **2**

**Bottom Lip Slides under Tab of Clip**

**1-22** Position center bracket onto clips as shown ensuring lip on bottom of bracket slides under tab on bottom of clip.

**Hole Located in Center of Vertical Rail**

**1** **2**

**1-23** Align hole on each end of bracket with designated hole on vertical frame. Install one M6-12 torx screw into each hole ensuring bracket is secure on frame.

**NOTE: Do not tighten screws.**

**1** **2**

**Bring Clip/Screw Up** **Verify Clip is Latched to Lip of Center Bracket and Tighten Screw in UP Position**

**1-24** From inside of cabinet, bring center clip on each mounting rail up as shown ensuring clip is latched onto upper lip of center bracket. Ensure screw on clip is in UP position and tighten.

**NOTE: Torque each screw to 35-40 in-lbs of torque.**

**1-25** Tighten torx screw on each end of center bracket to vertical rails.

**NOTE: Torque each screw to 77-83 in-lbs of torque.**

# V600 Cabinet Assembly - Side Panel Assembly

**NOTE:**  
If side panels are not required, skip to Section 3 (Door Assembly)

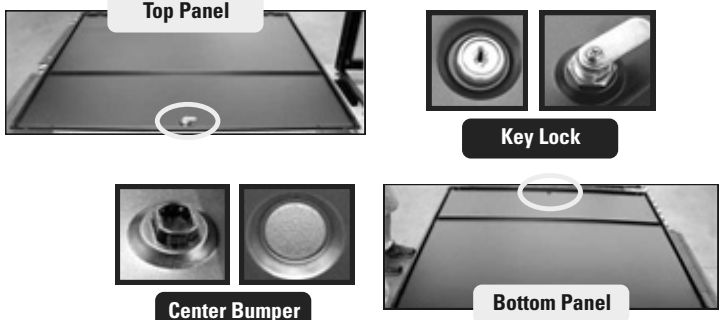

**Top Panel**

**Key Lock**

**Center Bumper**

**Bottom Panel**

**2-1** Note difference between bottom panel and top panel. Top panel has key lock installed and bottom panel has center bumper.

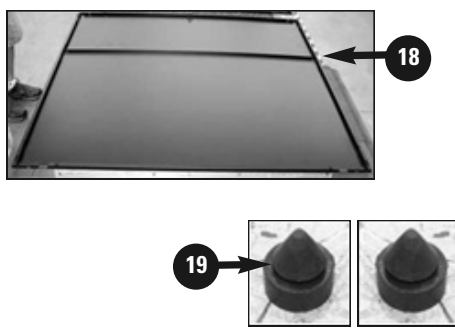

**18**

**19**

**2-2** Gather **one** designated bottom side panel [18] and **two** bumpers [19].

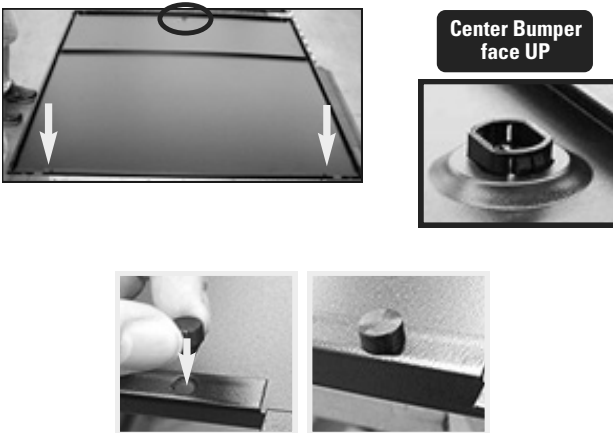

**Center Bumper face UP**

**2-3** Place bottom panel on bench with center bumper facing up. Install bumpers into designated holes on panel as shown. Ensure bumpers are secure.



**2-4** Locate ground clip on side panel. With a flathead screwdriver, carefully remove it from the slot and expand it over the lip of the panel as shown.



**Insert Bumper into Top hole in center of Vertical Rail**

**2-5** Gather **two** bumpers. Insert **one** bumper into designed hole on each frame as shown ensuring bumper is secure and in the correct location.

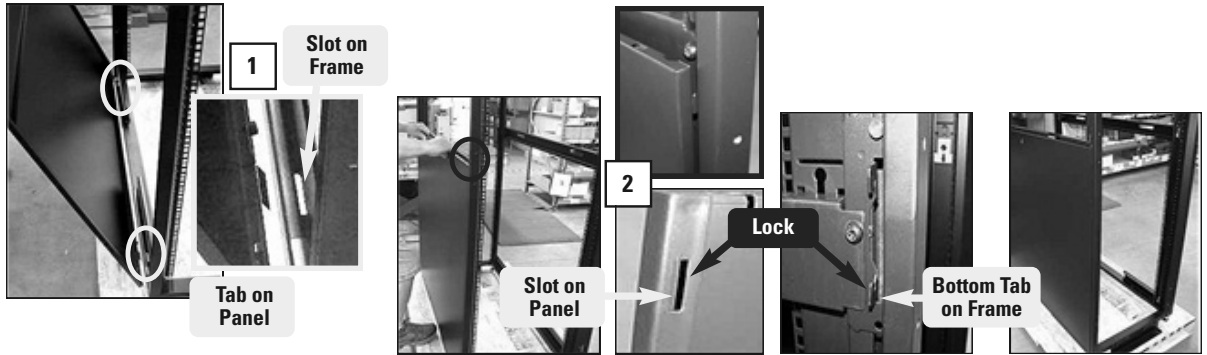

**2-6** Align tabs on bottom edge of bottom panel with designated slots on bottom of frame. Bring bottom panel up and lock slots on each end of panel with bottom tab on each side of frame. Ensure bottom panel is locked onto frame and is secure.

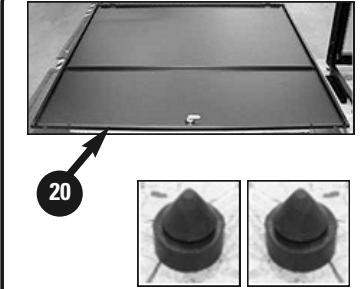

**2-7** Gather **one** designated top side panel [20] and **two** bumpers. Repeat step 2-4 for ground clips.

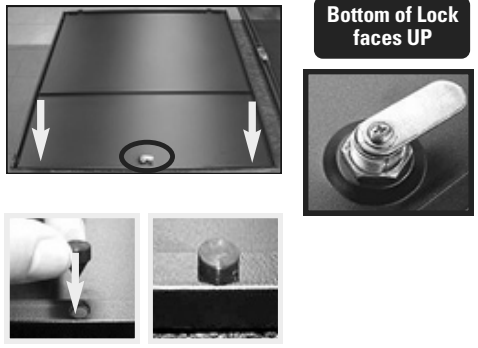

**2-8** Place top panel on bench with bottom of lock facing up. Install bumpers into designated holes on panel as shown. Ensure bumpers are secure.

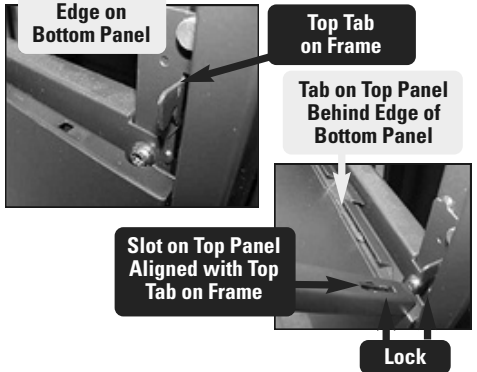

**2-9** Align slots on each side of top panel with top tabs on frame. Position tabs on top panel behind edge of bottom panel as shown and push panel up against frame.

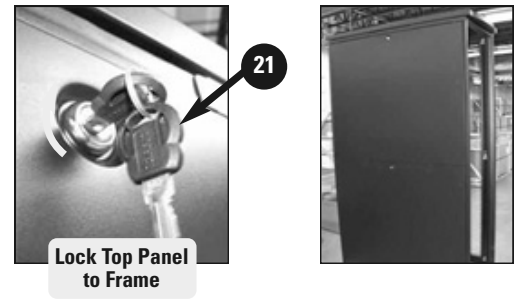

**2-10** Using key [21] lock top panel onto frame as shown ensuring panel is secure on frame. Remove key and set aside.

**NOTE: Repeat 2-1 to 2-10 if second set of panels is required.**

# V600 Cabinet Assembly - Door Assembly

**Full Vented - Steps 3F-1 to 3F-9**  
**Split Vented - Steps 3S-1 to 3S-4**

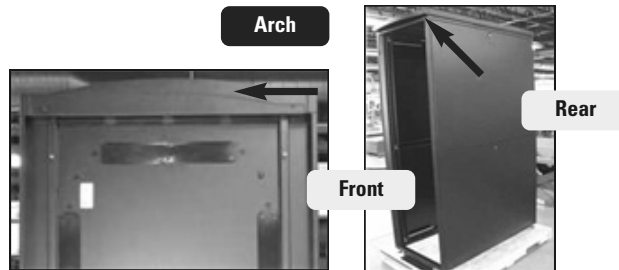

**NOTE:**  
**Front end of cabinet frame is indicated by arch on top panel. Ensure front door is installed on proper side.**

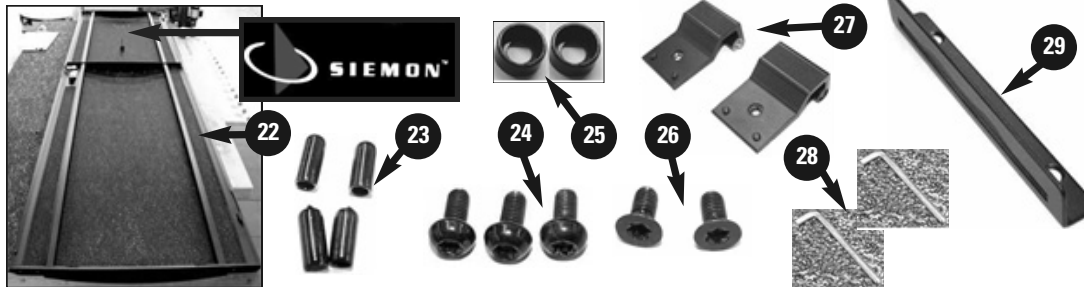

**3F-1** Gather **one** full-size front door with SIEMON branding plate [22], **four** closed end caps [23], **three** M6x12 torx head screws [24], **two** black plastic cup washers [25], **two** M6 taper screws [26], **two** door hinges [27], **two** door hinge pins [28] and **one** door latch bracket [29].



**3F-2** Position door latch on right side in front end of cabinet as shown ensuring holes on latch align with designated holes on vertical frame post.

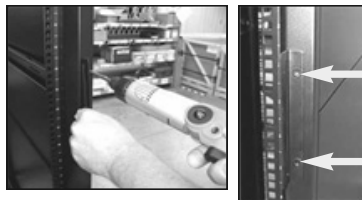

**NOTE: Torque each screw to 35-40 in-lbs of torque.**

**3F-3** Install **one** M6 taper screw into each indicated hole on latch/post as shown. Ensure latch is secure to frame of cabinet and is in correct location.



**3F-4** Place **one** closed end cap onto short end of each door hinge pin.



**3F-5** Affix **one** black cup washer onto end of door hinge. Slide door hinge pin through hinge ensuring short end of pin is away from cup washer on hinge as shown.

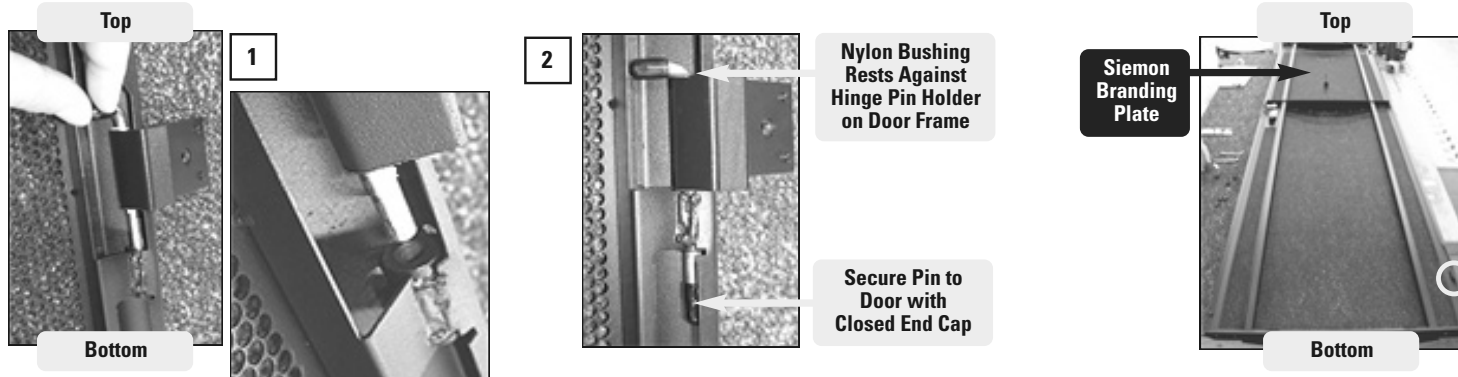

**3F-6** Slide hinge pin through designated hole on edge of the bottom of the door ensuring short end of pin faces towards top of door. Secure pin by inserting one closed end cap on bottom end of pin as shown.

**NOTE: Nylon bushing must rest against edge of hinge pin holder on door frame.**

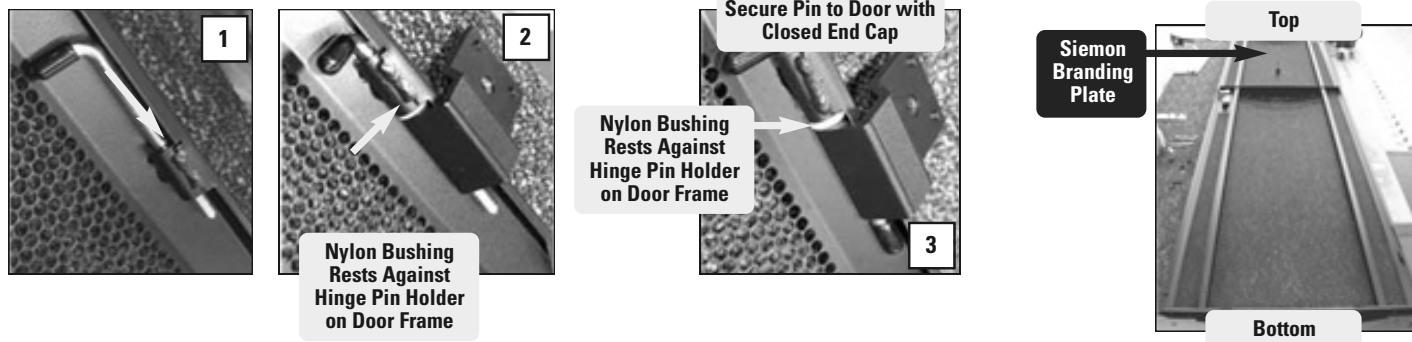

**3F-7** Slide hinge pin through designated hole on edge of the top of the door ensuring short end of pin faces towards top of door. Affix **one** nylon bushing onto end of remaining door hinge and slide hinge onto bottom of pin. Secure pin by inserting one closed end cap on bottom end of pin as shown.

**NOTE: Nylon bushing must rest against edge of hinge pin holder on door frame.**

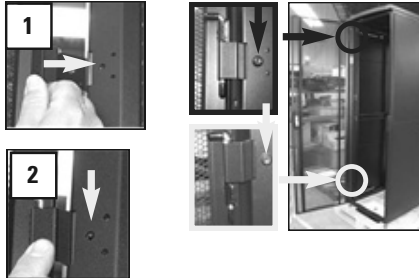

**Align Screw Holes**

**3F-8** Slide ends of hinges through hinge slots on cabinet frame ensuring screw hole on hinge aligns with designated hole on frame. Install **one** M6x12 Torx Head Screw through each indicated hole as shown ensuring hinges are secured to frame.

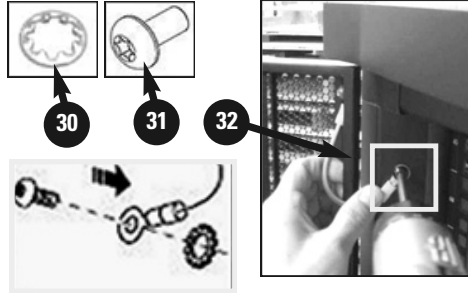

**3F-9** Gather **one** ground wire [32], **one** star washers [30] and **one** M6-12 torx screw [31]. Connect ground wire to the frame as shown to door.

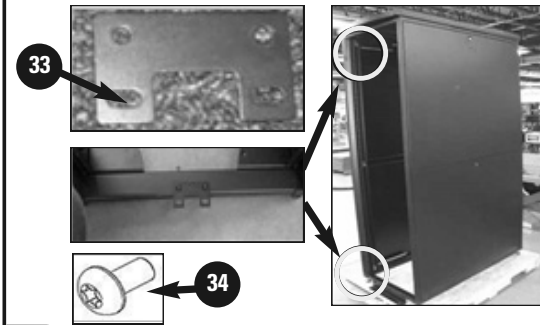

**3S-1** Gather **two** split door brackets [33], **four** M6-12 screws [34]. Install to frame on top and bottom as shown.

**NOTE: Torque each screw to 35-40 in-lbs of torque using configuration 2 on power screwdriver S-0819.**

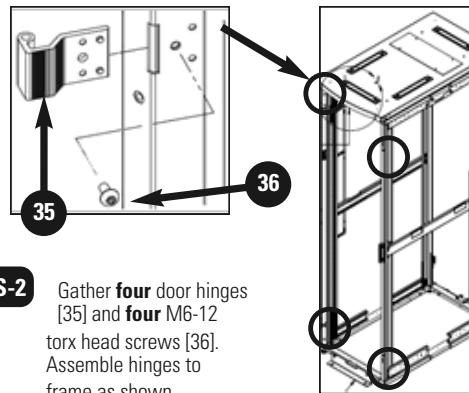

**3S-2** Gather **four** door hinges [35] and **four** M6-12 torx head screws [36]. Assemble hinges to frame as shown.

**NOTE: Torque each screw to 35-40 in-lbs of torque using configuration 2 on power screwdriver S-0819.**

**Left door – lip    Right door - lock**

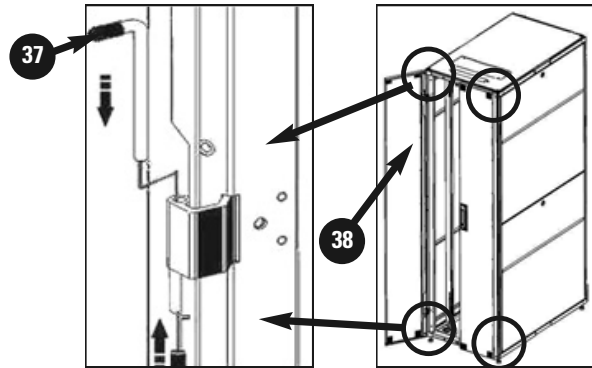
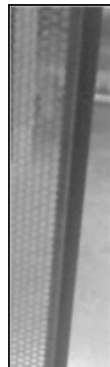

**3S-3** Gather **one** split door set [37] and **four** closed end caps [38]. Left hand door is identified with lip while right hand door contains locking mechanism. Assemble both doors to frame as shown.

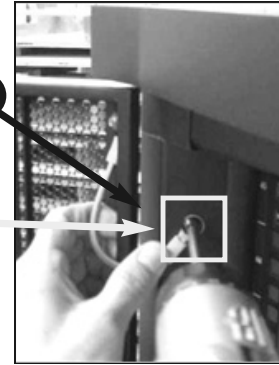
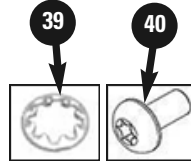
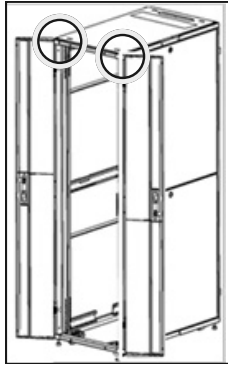
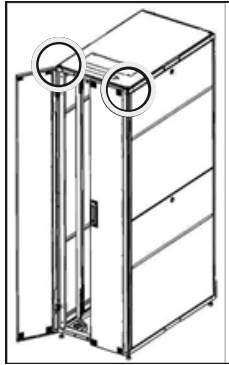

**3S-4** Gather **two** ground wire [41], **two** star washers [39] and **two** M6-12 torx screws [40]. Connect ground wire to the frame as shown to both doors.

**NOTE: Torque each screw to 35-40 in-lbs of torque.**

**Global Headquarters**  
Watertown, Connecticut USA  
Tel: (1) 866-548-5814  
For a complete listing of our global offices visit our web site

