

MapIT® G2 MCP to DCP Instructions

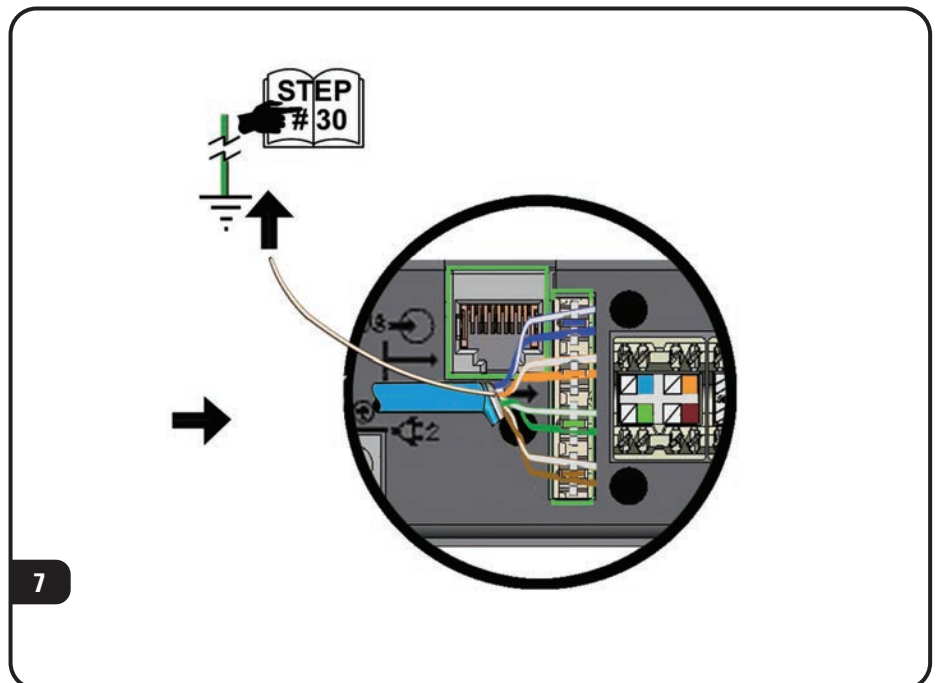

MapIT® G2 MCP to DCP Instructions

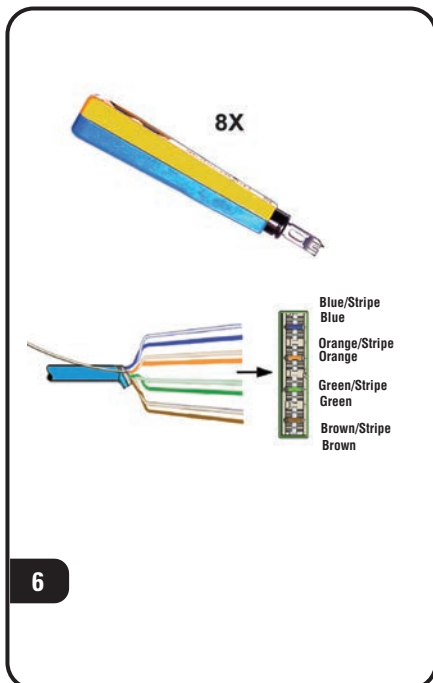
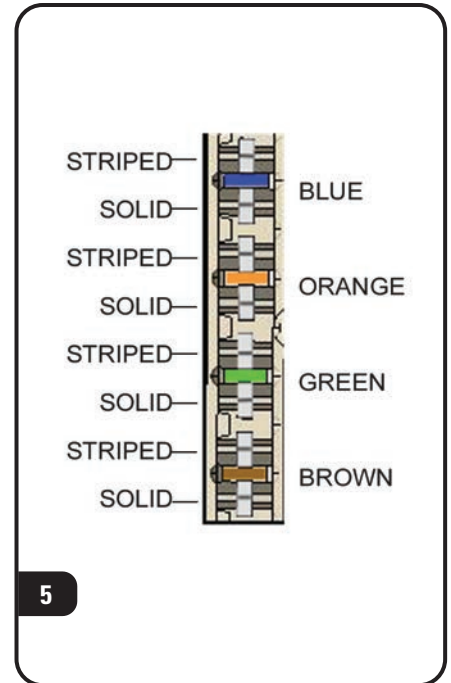
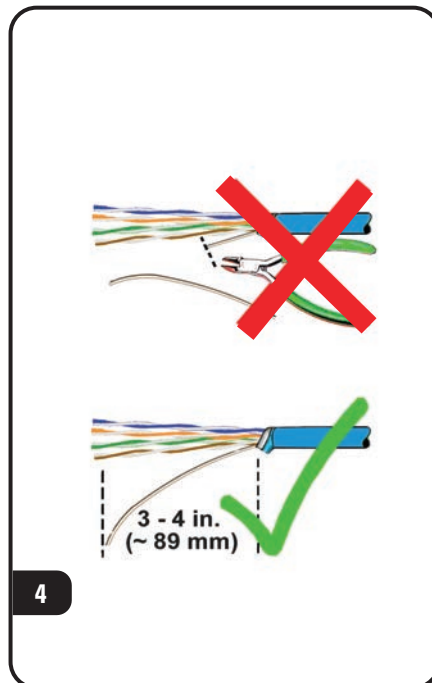
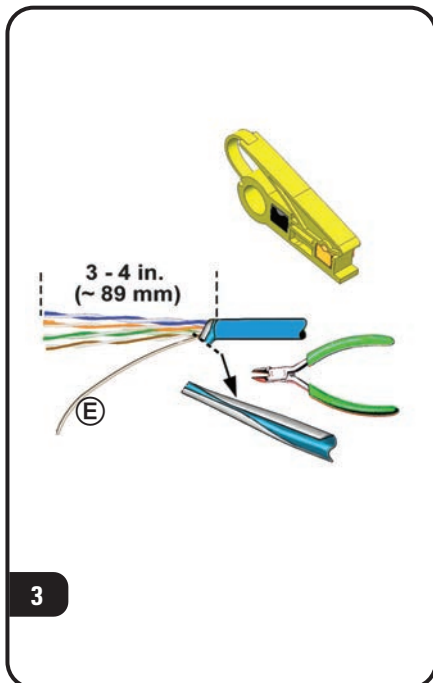
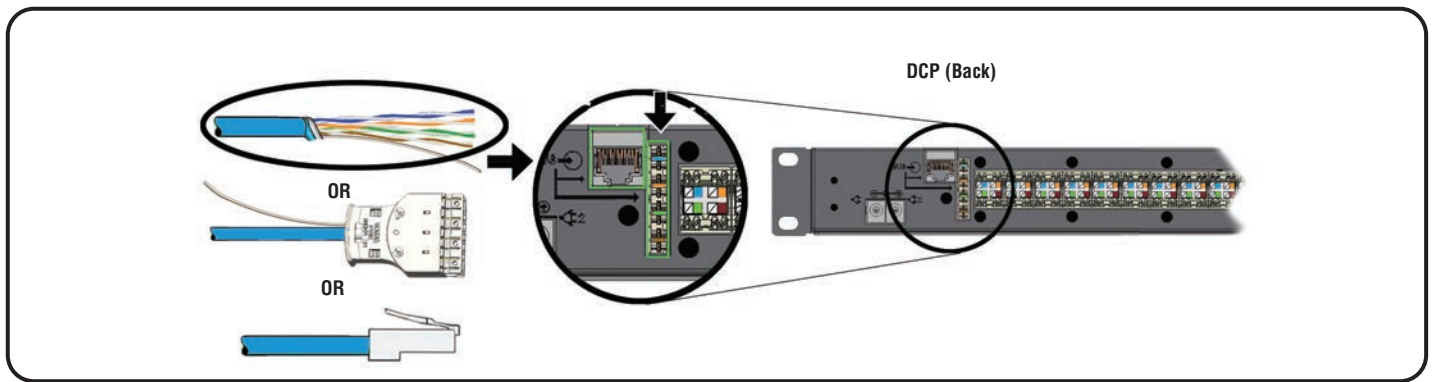
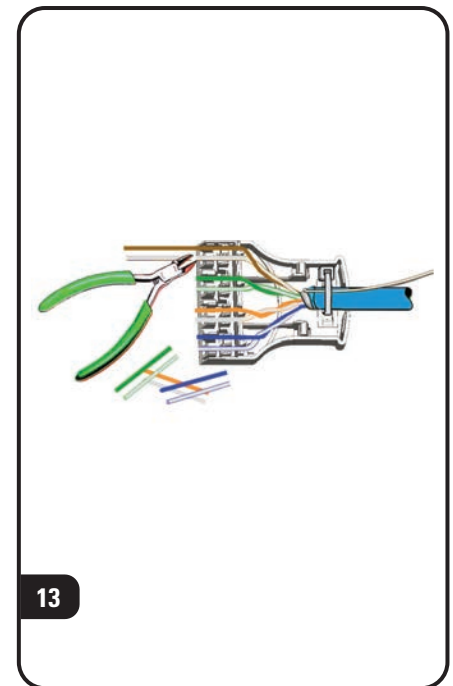
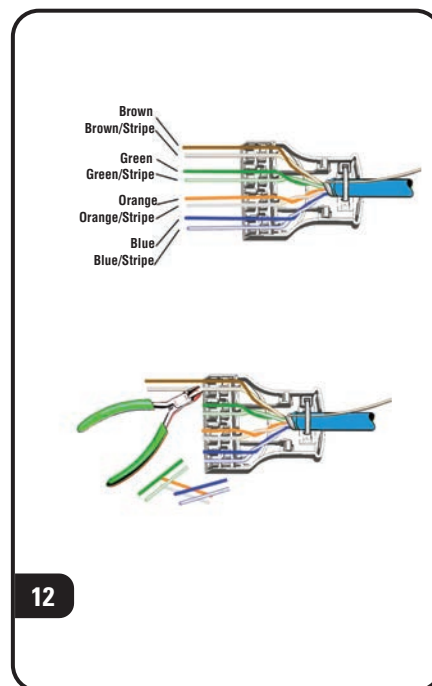
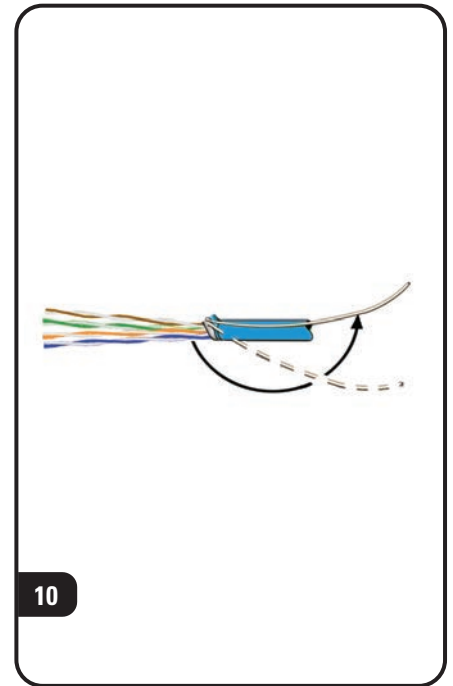
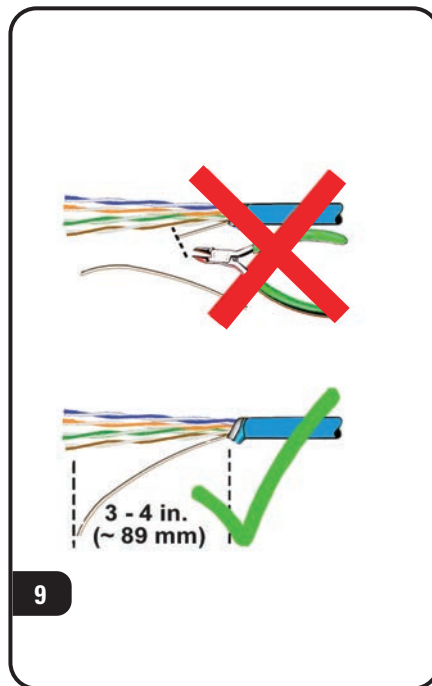
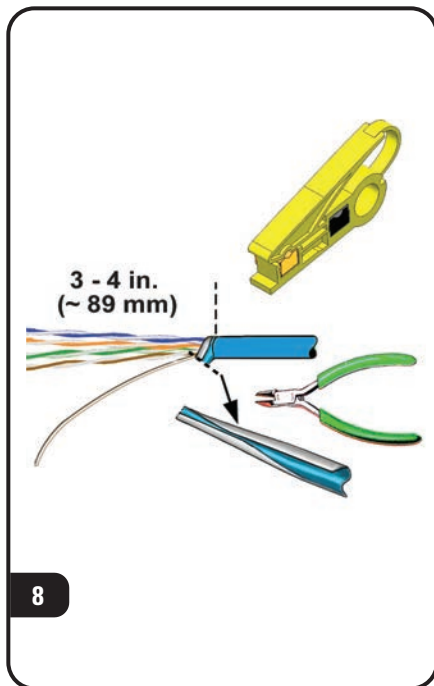
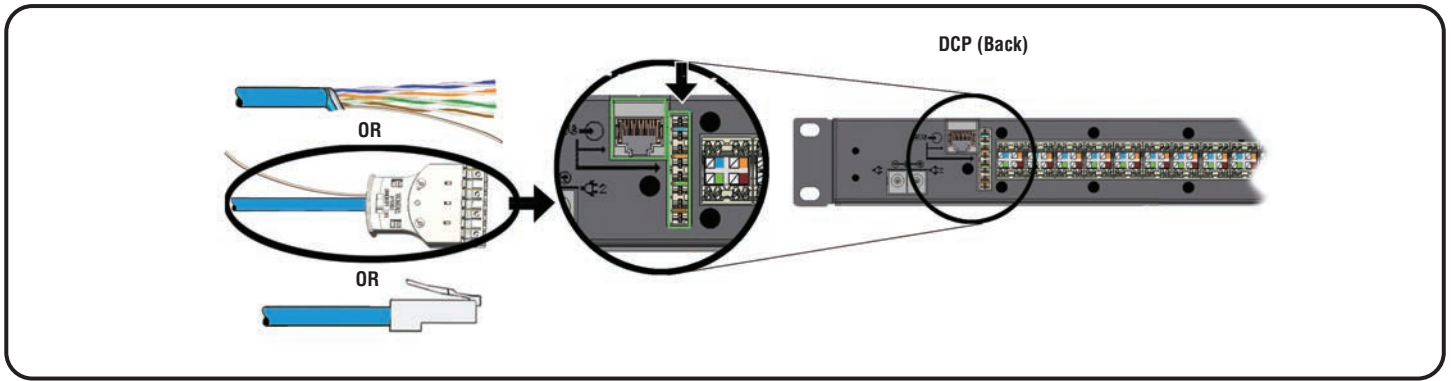

MapIT[®] G2 MCP to DCP Instructions

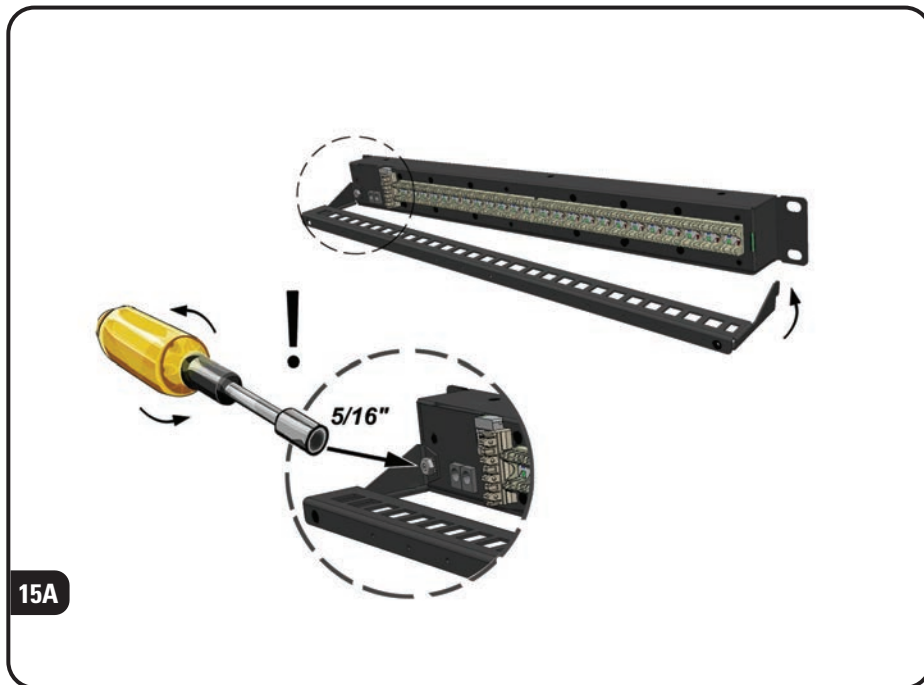
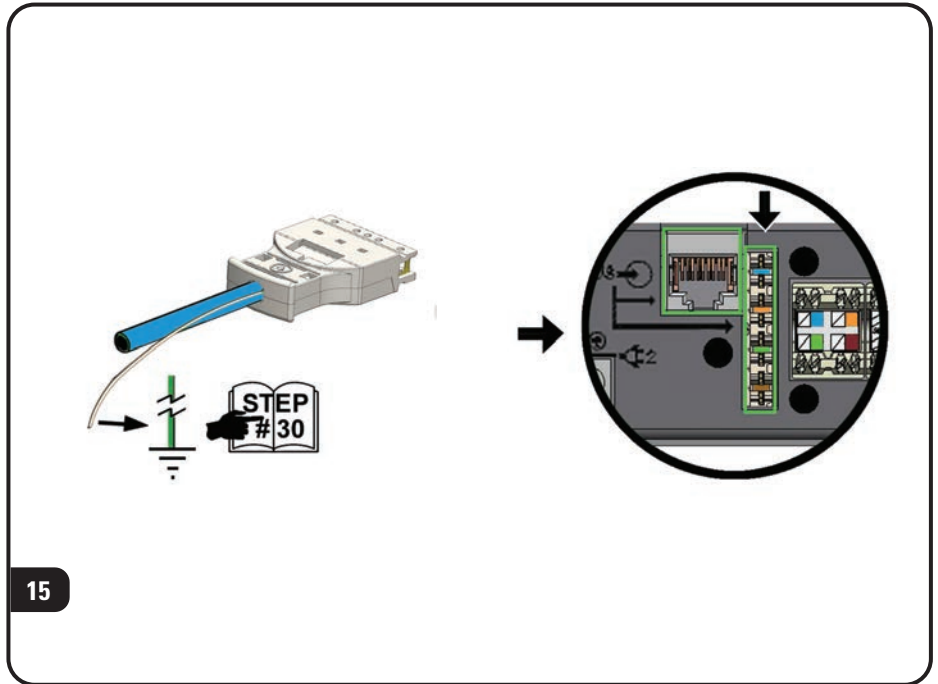
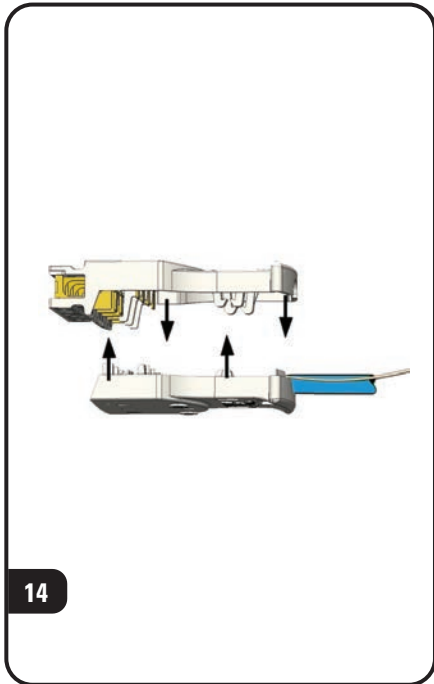

MapIT[®] G2 MCP to DCP Instructions

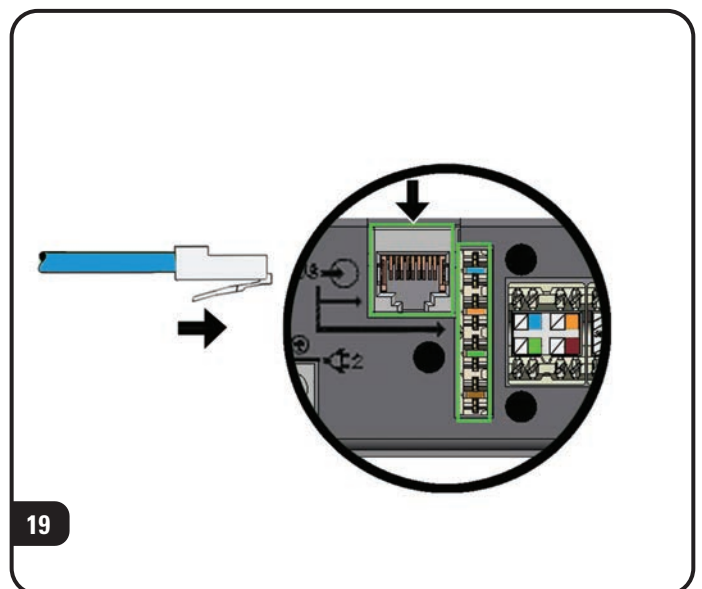
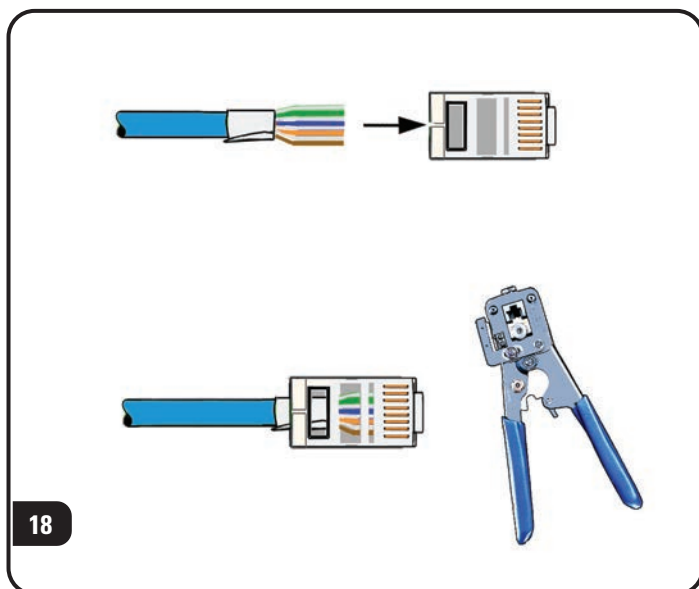
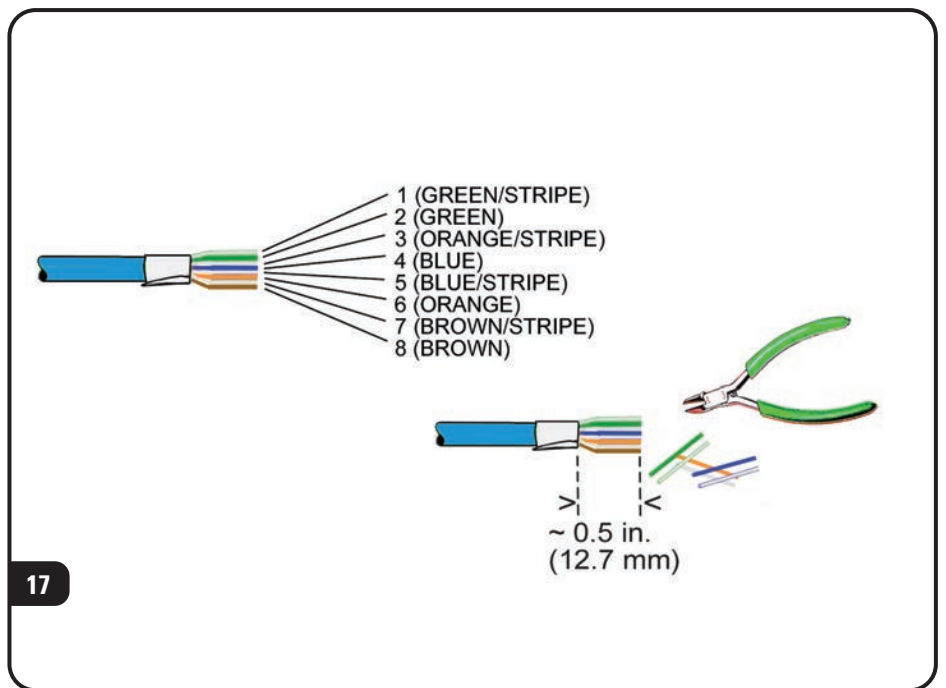
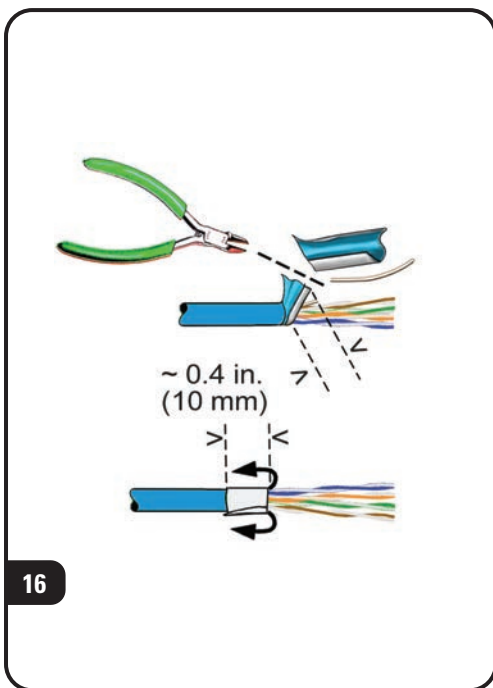
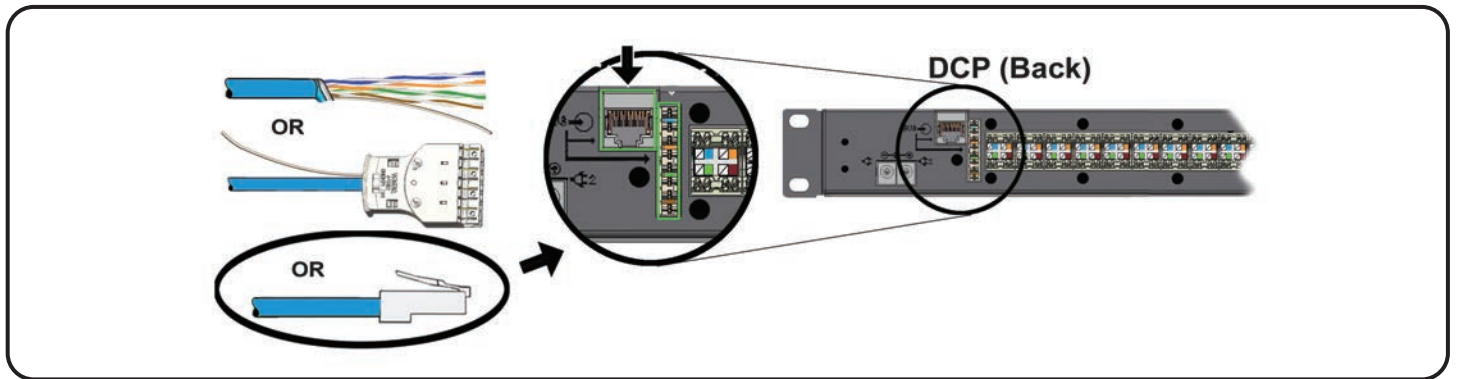

MapIT[®] G2 MCP to DCP Instructions

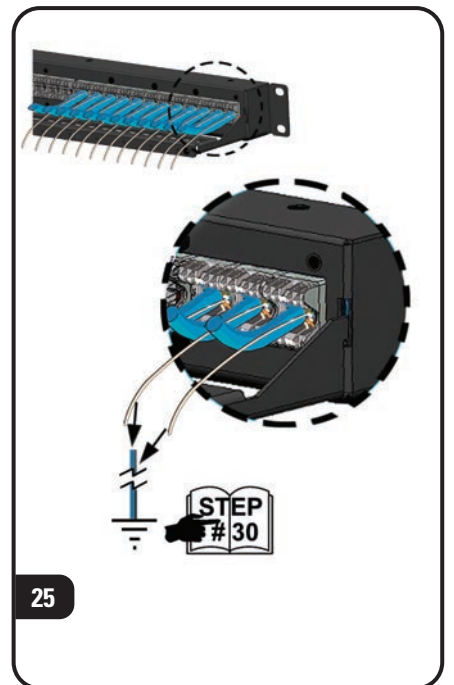
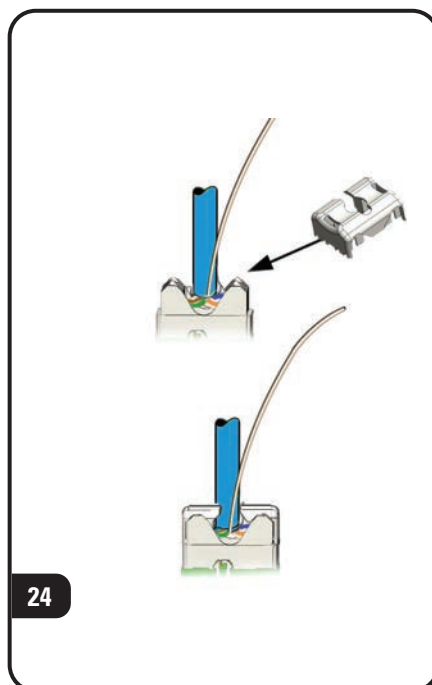
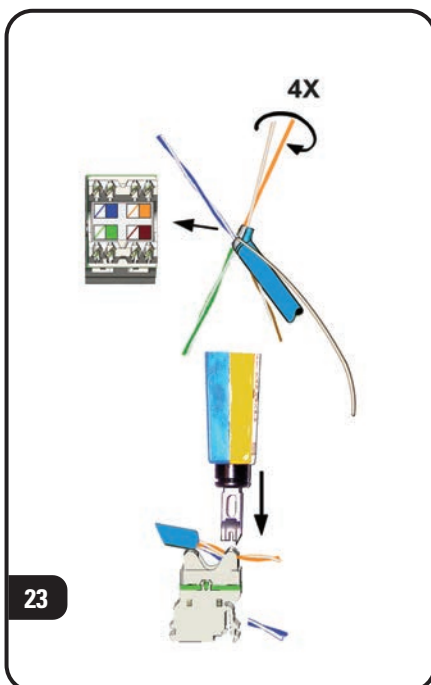
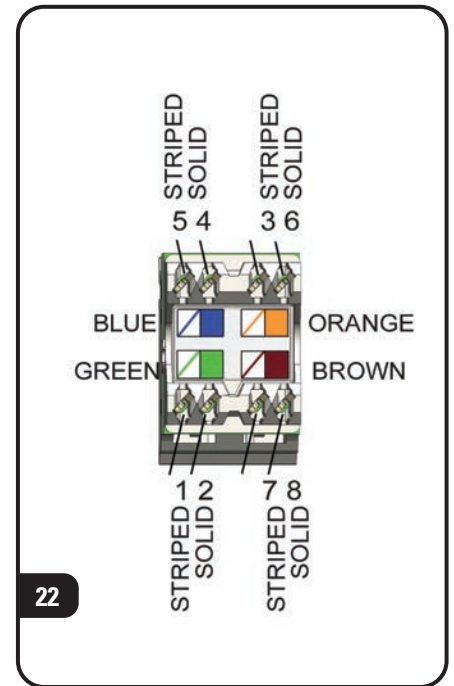
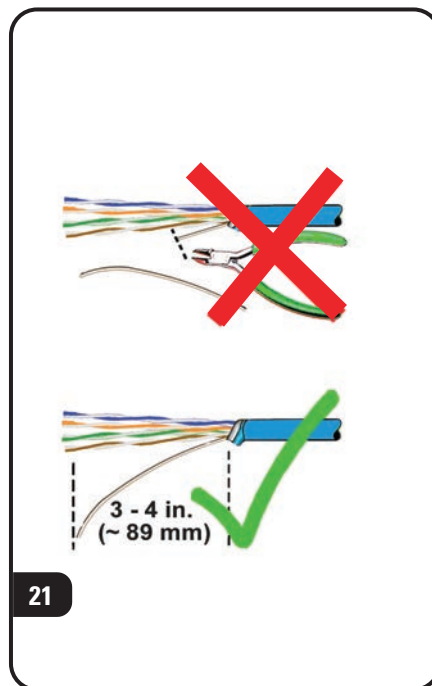
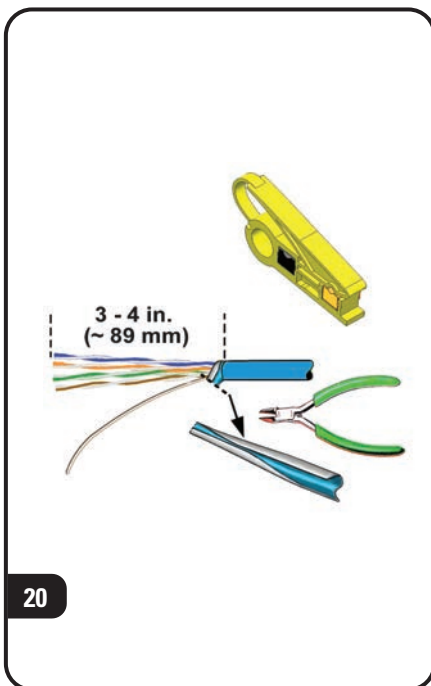
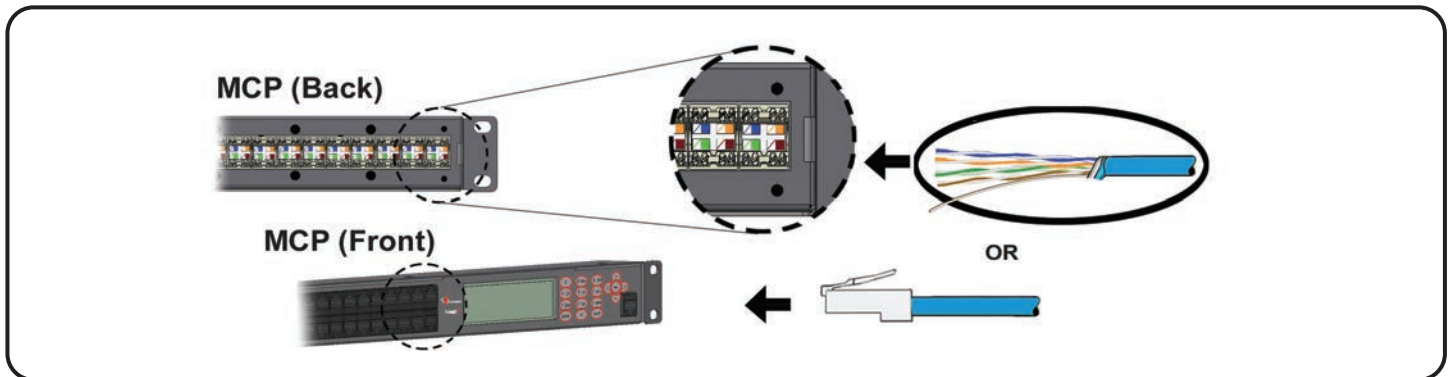

MapIT[®] G2 MCP to DCP Instructions

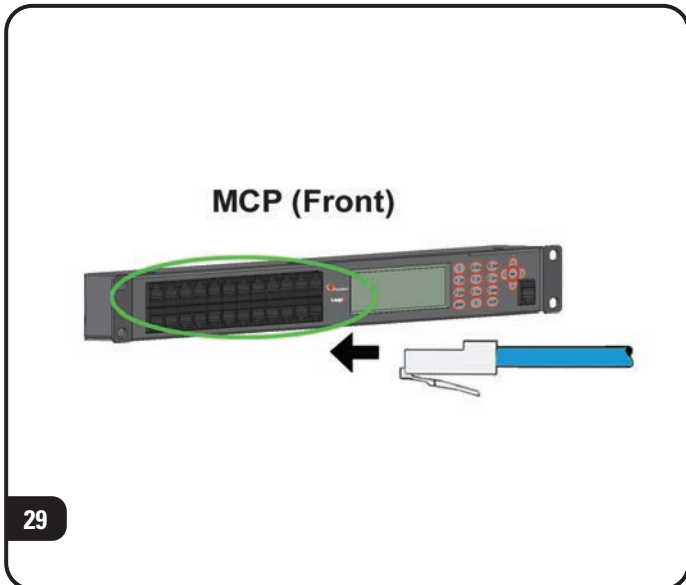
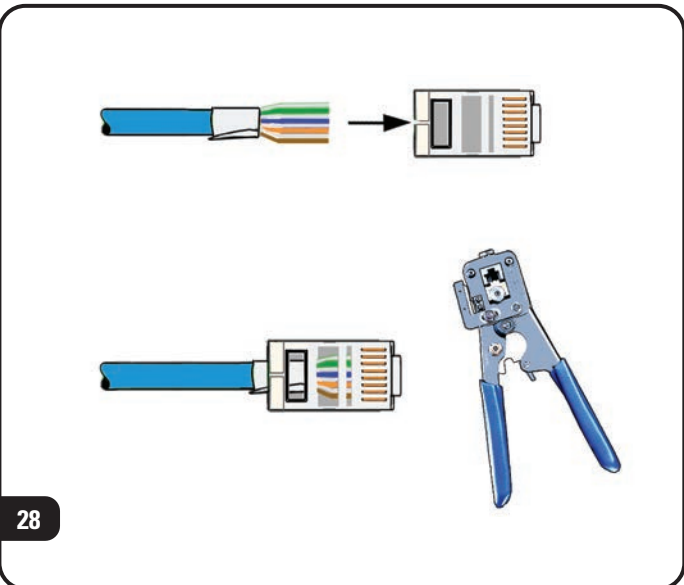
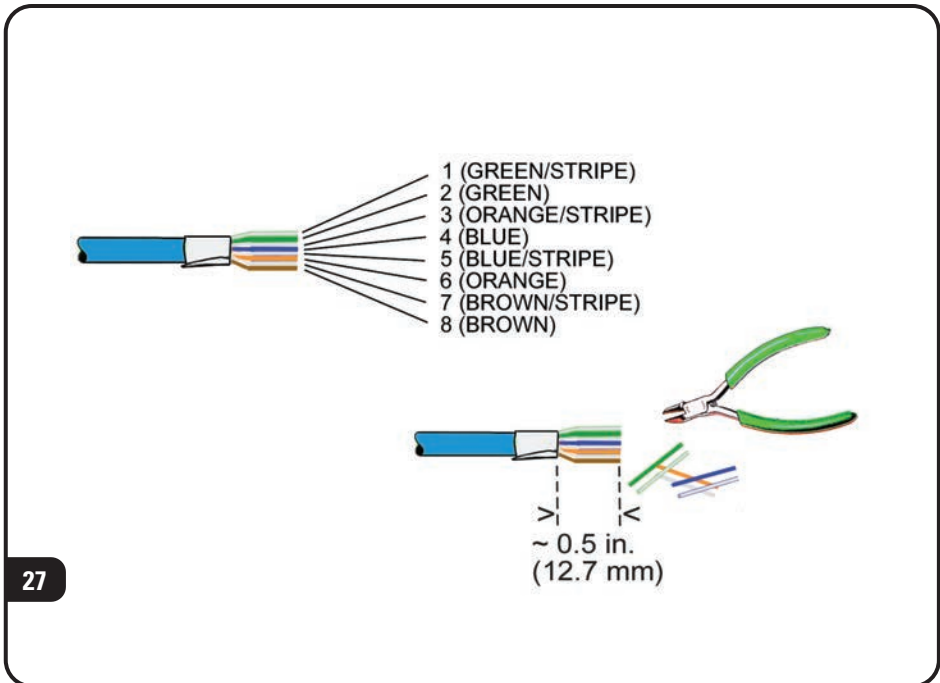
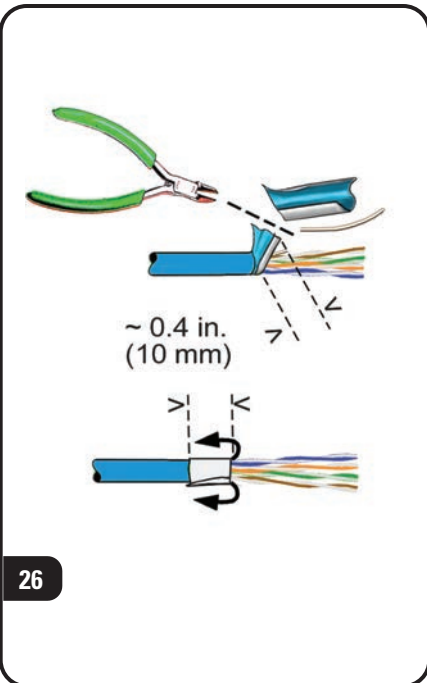
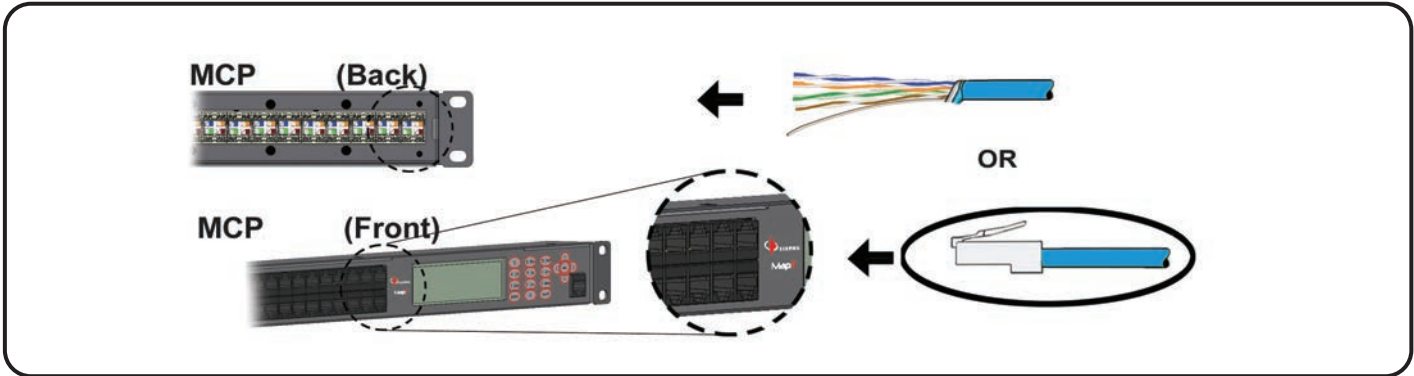

Drain Wire Terminations

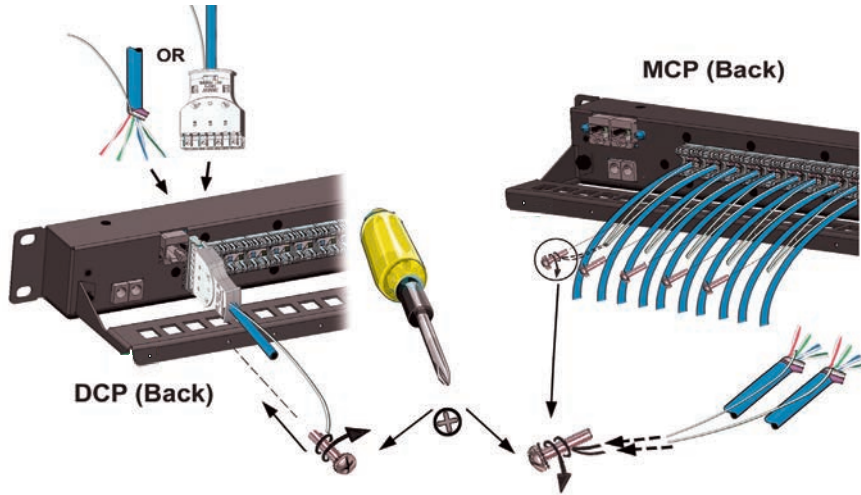

30

Ground Wire Terminations

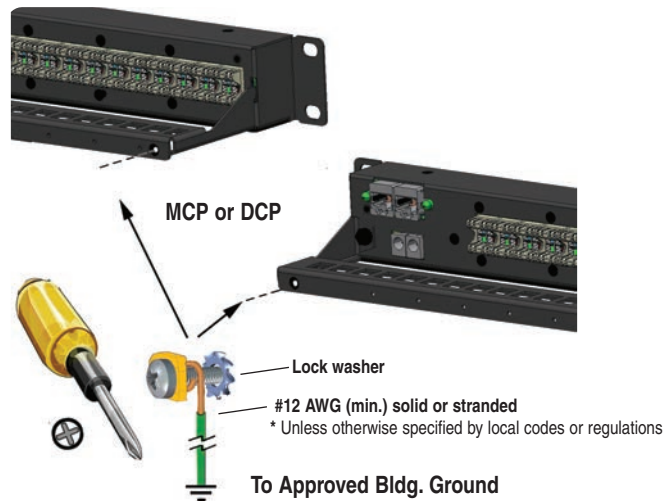

31



32

To assist safe installations, comply with the following:

- A. Use caution when installing or modifying telecommunications circuits.
- B. Never touch uninsulated wire terminals unless the circuit has been disconnected.
- C. Never install this device in a wet location.
- D. Never install wiring during a lightning storm.

Lors de l'installation, respectez les consignes de sécurité suivantes:

- A. Utiliser avec prudence lors de l'installation ou de la modification circuits de télécommunications.
- B. Ne jamais toucher les bornes de fil métallique non isolés sauf si le circuit a été débranché.
- C. Ne jamais installer cet appareil dans un endroit humide.
- D. Ne jamais installer pendant un orage.

To ensure you have the latest revision to this document please visit www.siemon.com

Global Headquarters
Watertown, Connecticut USA
Tel: (1) 866-548-5814

For a complete listing of our global offices visit our web site

