

# LightVerse Rear Spool Manager

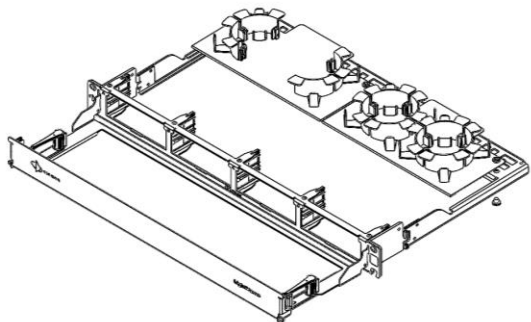

## Hardware

- A. Rear Spool Manager
- B. Quarter round fiber managers (8)
- C. Tray Screw (2)



## Tools

Philips head screwdriver

1 Left and right rear spool manager mounting positions.

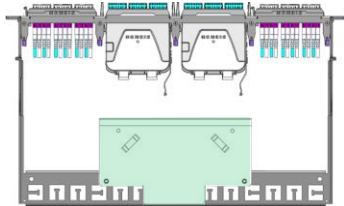
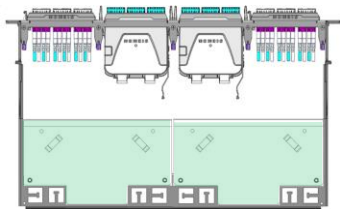

Center rear spool manager mounting position.

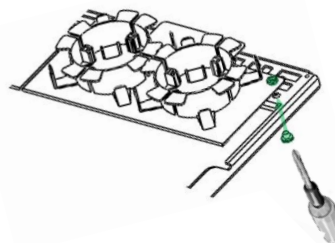
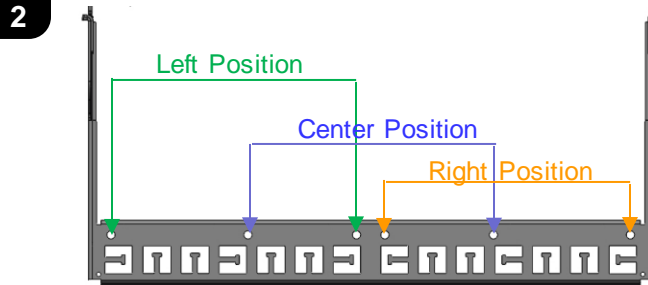

Spool tray mounting screws mount on the underside of the rear cable manager as shown.

3 Quarter round fiber managers lock into position on the internal tray by sliding the tab under the lances until the lock pin engages into the hole in the tray.

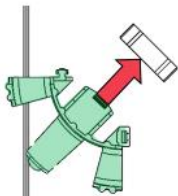

To remove: 1. lift bottom manager and 2. slide out.

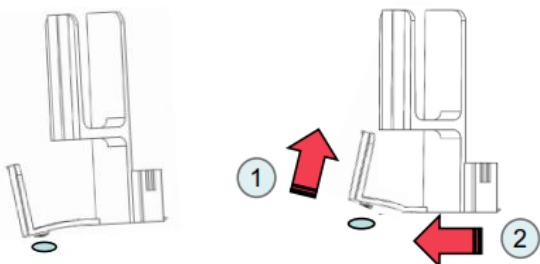

4 Quarter round fiber managers can be used to create 2 half circles or 1 complete circle ring (shown below).

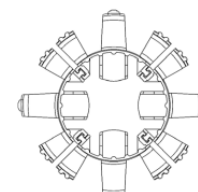
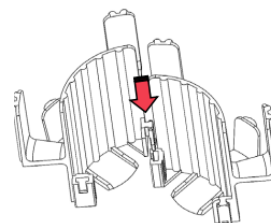
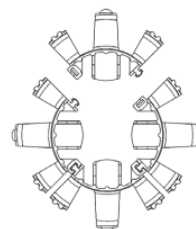

# LightVerse Rear Spool Manager

5

Quarter round fiber manager mounting examples

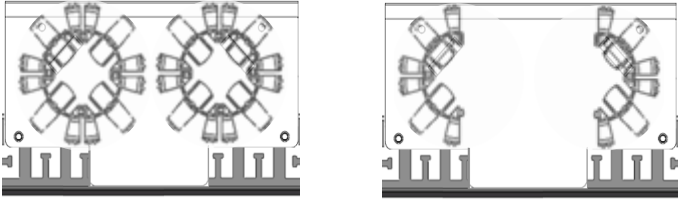

6

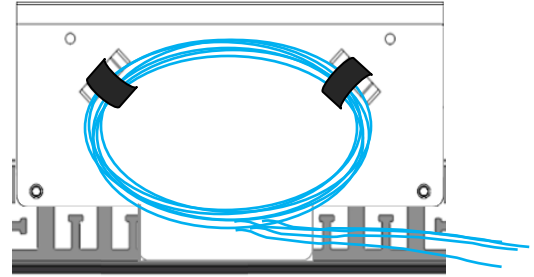

When managing large volumes of fiber, Velcro loops may alternatively be used in lance points as shown.

## Comply with the following for safe installations:

- A. Use caution when installing or modifying telecommunications circuits.
- B. Never touch uninsulated wire terminals unless the circuit has been disconnected.
- C. Never install this device in a wet location.
- D. Never install wiring during a lightning storm.



Global Headquarters  
Watertown, Connecticut USA  
Tel: (1) 866-548-5814



For a complete listing of our global offices visit our web site